

## GENERAL SPECIFICATIONS

### Electrical Capacity

**Resistive Load:** 15A & ½ HP @ 125 or 250V AC for high capacity models  
**Lamp Load:** 5A @ 125V AC

### Other Ratings

**Contact Resistance:** 15 milliohms maximum  
**Insulation Resistance:** 100 megohms minimum @ 500V DC  
**Dielectric Strength:** 1,000V AC minimum between contacts for 1 minute minimum;  
 1,500V AC minimum between contacts & case for 1 minute minimum  
**Mechanical Life:** 1,000,000 operations minimum  
**Electrical Life:** 50,000 operations minimum  
**Travel:** Pretravel .047" (1.19mm); Overtravel .040" (1.01mm); Differential .011" (0.27mm)  
**Operating Temp Range:** -40°C through +85°C (-40°F through +185°F)

### Materials & Finishes

**Caps & Shrouds:** Polycarbonate with glossy finish or PBT  
**Plunger:** Polyacetal or brass with nickel plating  
**Bushing:** Steel with zinc plating or glass fiber reinforced polyamide  
**Case:** Polyester  
**Movable & Stationary Contacts:** Silver alloy  
**Terminals:** Brass with silver plating

### Standards & Certifications

**UL:** Internal snap switch is UL recognized.  
**CSA:** Internal snap switch is CSA certified.

## TYPICAL SWITCH ORDERING EXAMPLE

**SCB** **2** **5** **P** **15** **A** — **4** **CA**

Poles	
1	SPDT
2	DPDT

Circuits		
5	ON	(ON)
6	ON	ON
( ) = Momentary		

Bushings	
P	Plastic (with momentary only)
S	Steel

Rating	
15	15A

Terminals	
A	.187" (4.75mm) Quick Connect
* B	.250" (6.35mm) Quick Connect
Note: Contact factory for availability of screw lug and solder lug models.	
* Available in Americas only	

Caps & Shrouds	
For Momentary	
3	.520" (13.2mm) Diameter Cap
For Momentary & Alternate Action	
4	Round Cap & Shroud (AT454 & AT455)
5	Rectangular Cap & Shroud (AT452 & AT453)

Colors		
Caps	Shrouds	
A	Black	A
B	White	B
C	Red	-
F	Green	-
G	Blue	-
H	Gray	H

**DESCRIPTION FOR TYPICAL ORDERING EXAMPLE**

**SCB25P15A-4CA**

Round Red Cap with Black Shroud  
 Plastic Bushing  
 DPDT ON-(ON) Circuit  
 15A Rating  
 .187" (4.75mm) Quick Connect Terminals

Note: Standard hardware is provided with caps. See Bushing detail for more information.

Toggles

Rockers

Pushbuttons

Illuminated PB

Keylocks

Rotaries

Slides

Tactiles

Tilt





Touch

Indicators

Accessories

Supplement

## POLES & CIRCUITS

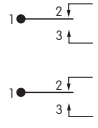
		Plunger Position ( ) = Momentary		Connected Terminals		Throw & Schematics
Pole	Model	Normal  Keyway	Down 	Normal  Keyway	Down 	Note: Terminal numbers are actually on the switch.
SP	SCB15 SCB16	ON ON	(ON) ON	1-2	1-3	
DP	SCB25 SCB26	ON ON	(ON) ON	1-2 1-2	1-3 1-3	SP with 2 switches 

## BUSHINGS

**P** Plastic  
(for Momentary only)

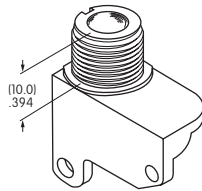

**S** Steel

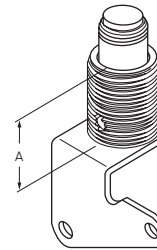

"A" =  
11.2mm  
Momentary  
15.5mm  
Alternate Action

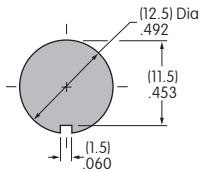

Maximum Effective Panel Thickness:  
.165" (4.2mm) without Shroud  
.157" (4.0mm) with Shroud

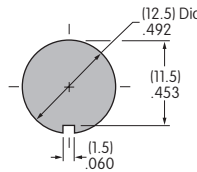

Maximum Effective Panel Thickness:  
Momentary: .177" (4.5mm) without Shroud  
.157" (4.0mm) with Shroud  
Alternate Action: .354" (9.0mm)

### Standard Hardware Provided with Caps

Cap Option 3: AT504M Knurled Face Nut, AT508 Lockwasher, AT527M Hex Mounting Nut

Cap Options 4 & 5: AT508 Lockwasher & AT527M Hex Mounting Nut

## TERMINALS

**A** .187" (4.75mm)  
Quick Connect

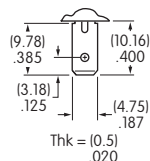

**B** .250" (6.35mm)  
Quick Connect

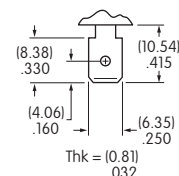

TYPICAL SWITCH DIMENSIONS

.520" (13.2mm) Dia. Cap • .187" (4.75mm) Quick Connect

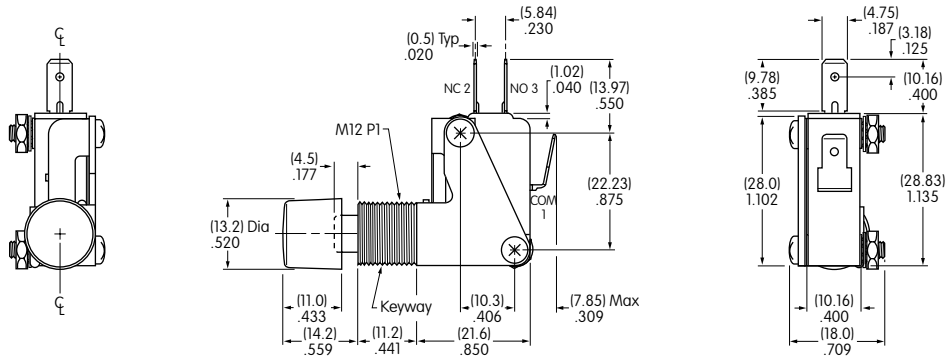

SCB15S15A-3C

Round Cap & Shroud • .187" (4.75mm) Quick Connect

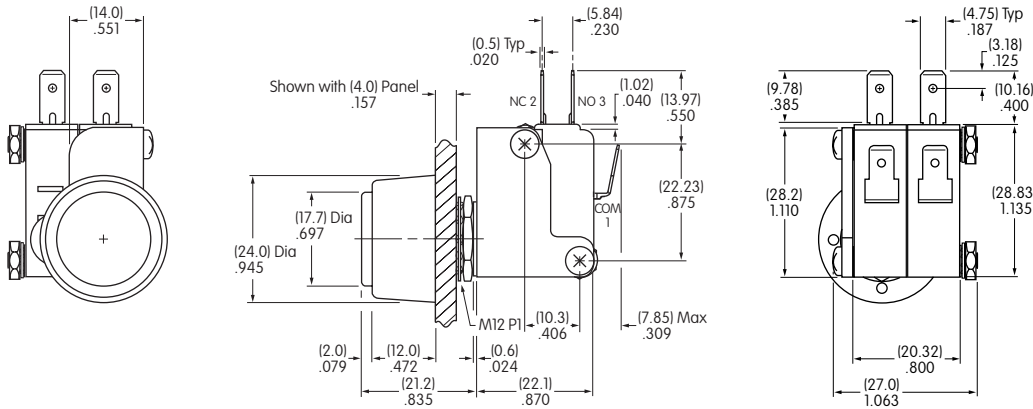

SCB25P15A-4CA

Rectangular Cap & Shroud • .250" (6.35mm) Quick Connect

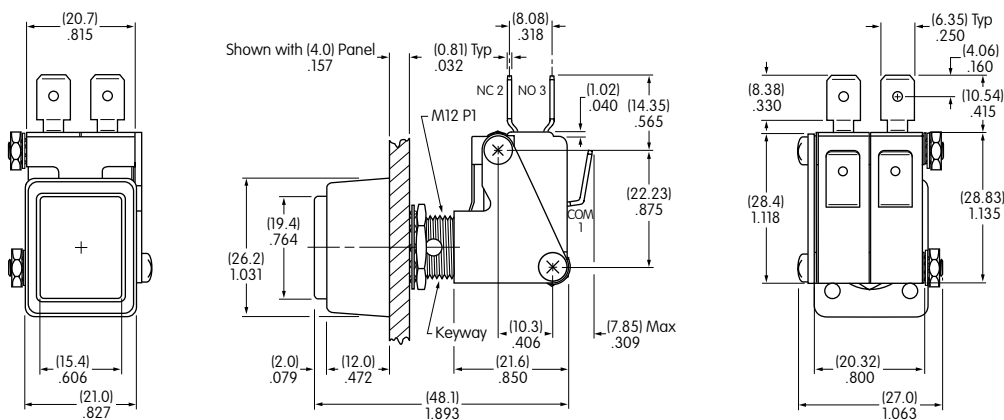

SCB26S15B-5CA